

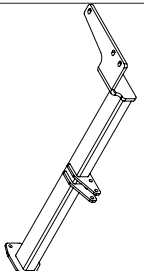

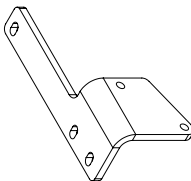







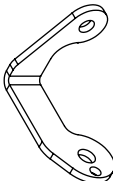







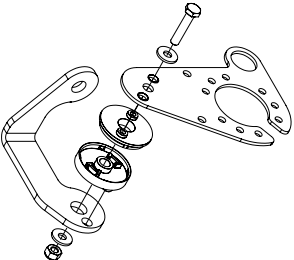
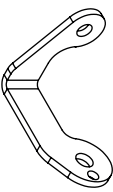

1		X1	GDW REF. 2239
2		X1	GDW REF. 2
3		X6	GDW REF. 3
4		X1	GDW REF. 4
5		X8	DIN934-M12
6		X8	DIN128A-M12
7		X12	DIN9021-M12-ELVZ
8		X6	DIN931-M12X150
9		X2	DIN933-M12 X 40
10		X2	DIN125-A12-140HV- ELVZ
-S		X1	GDW REF. 900.053

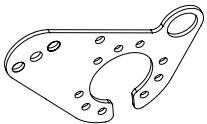
-P		X1	GDW REF. P38 + REF. -V
↳		X1	GDW REF. 4
↳		X1	DIN985-M6
↳		X2	6,2 X 15,4 X 1,6 (NYLON)
↳		X1	GDW REF. 718.16.002
↳		X1	GDW REF. 718.16.003
↳		X1	GDW REF. 908.094
↳		X1	DIN933-M6 X 30

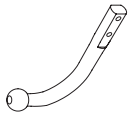
Geleverd met - Livré avec - Delivered with Geliefert mit - Elementos adjuntos-Leveres med		
	X1	944.H034
	X2	GDW REF. 900.008
	X2	GDW REF. 900.011 Ø 21.3 X 11.7
	X4	DIN931-M12 X 70
	X4	DIN985-M12

7

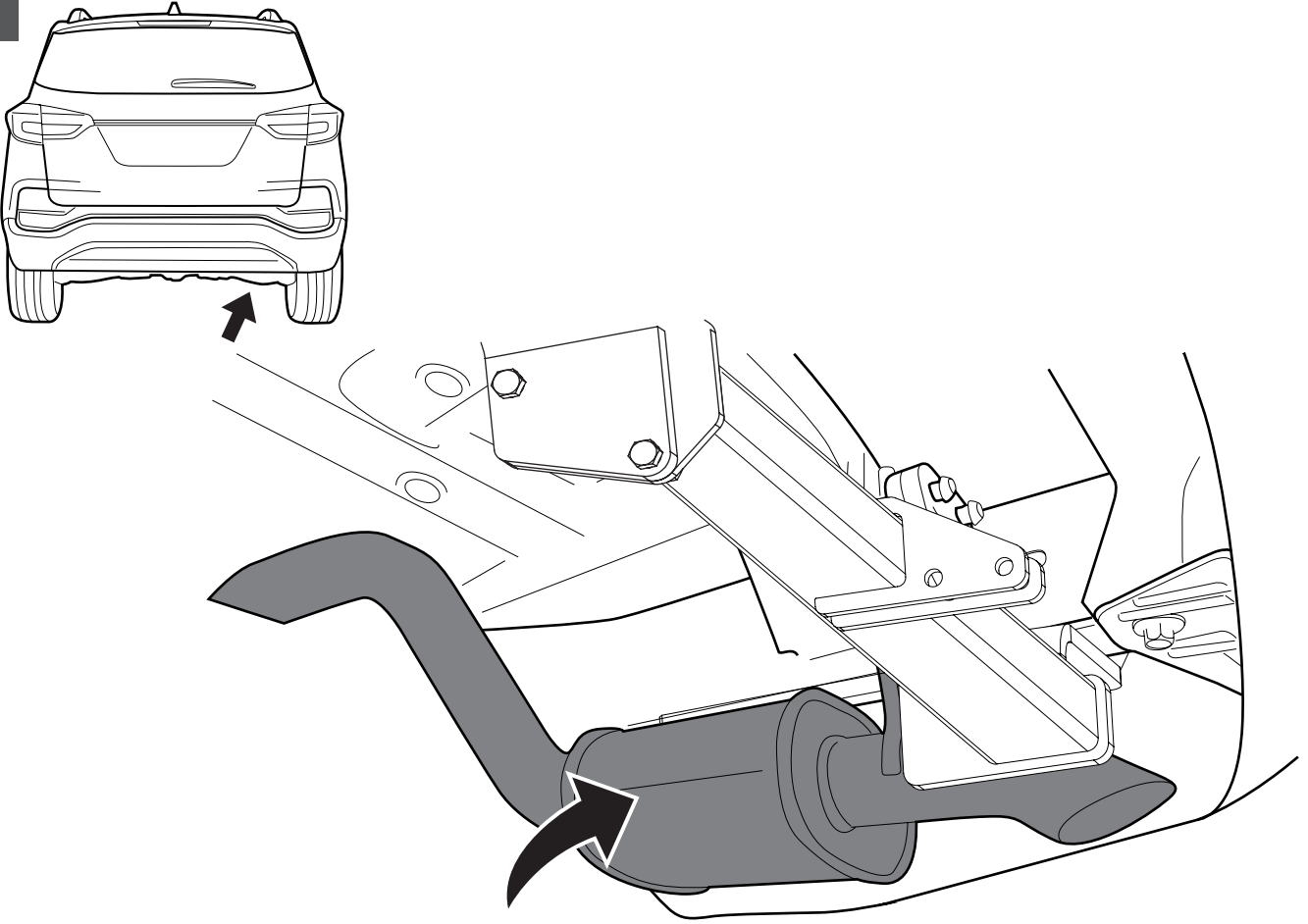

8

A		X1	GDW REF. 4
B		X1	DIN985-M6
C		X2	6,2 X 15,4 X 1,6 (NYLON)
D		X1	GDW REF. 718.16.002
E		X1	GDW REF. 718.16.003
F		X1	GDW REF. 908.094
G		X1	DIN933-M6 X 30

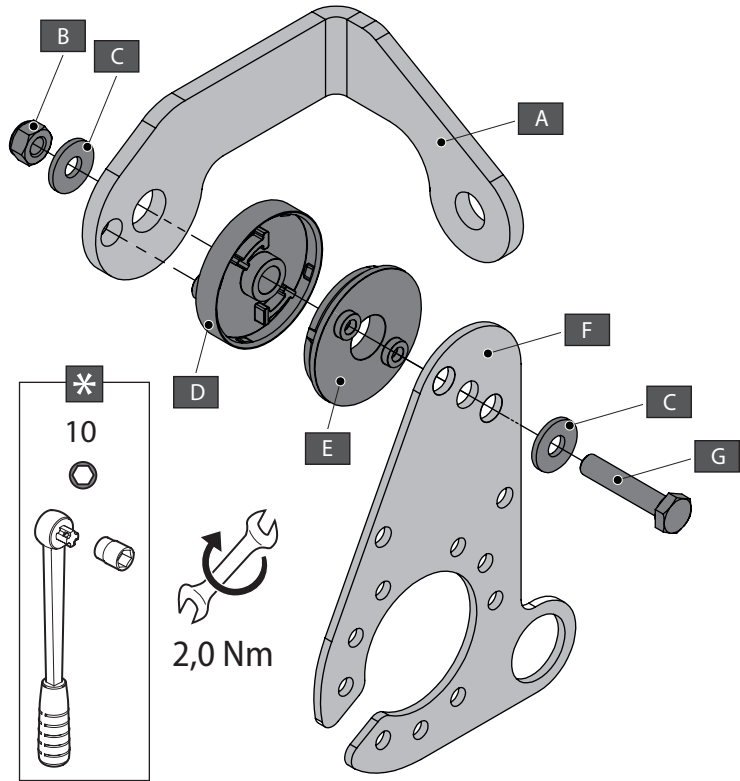

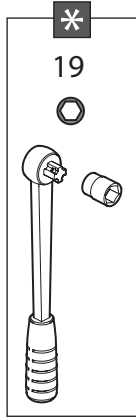

93,0 Nm

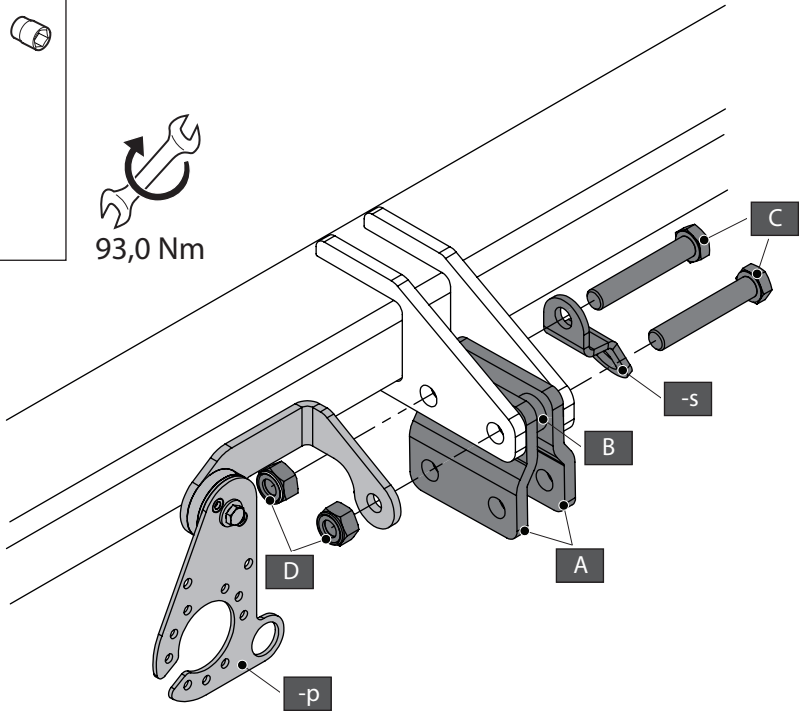

A		X2	GDW REF. 900.008
B		X2	GDW REF. 900.011 Ø 21,3 X 11,7
C		X2	DIN931-M12 X 70
D		X2	DIN985-M12
-S		X1	GDW REF. 900.053

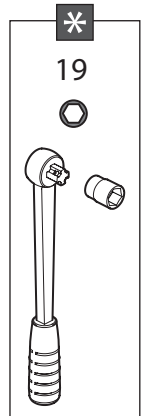

93,0 Nm

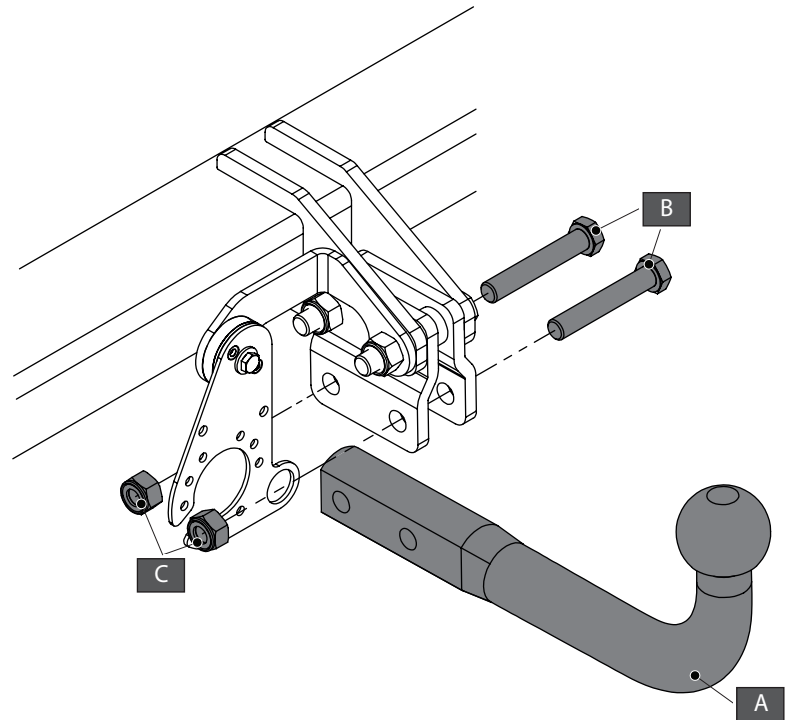

A		X1	944.H034
B		X2	DIN931-M12 X 70
C		X2	DIN985-M12